

# CABLE TRAY/LADDER COVERS

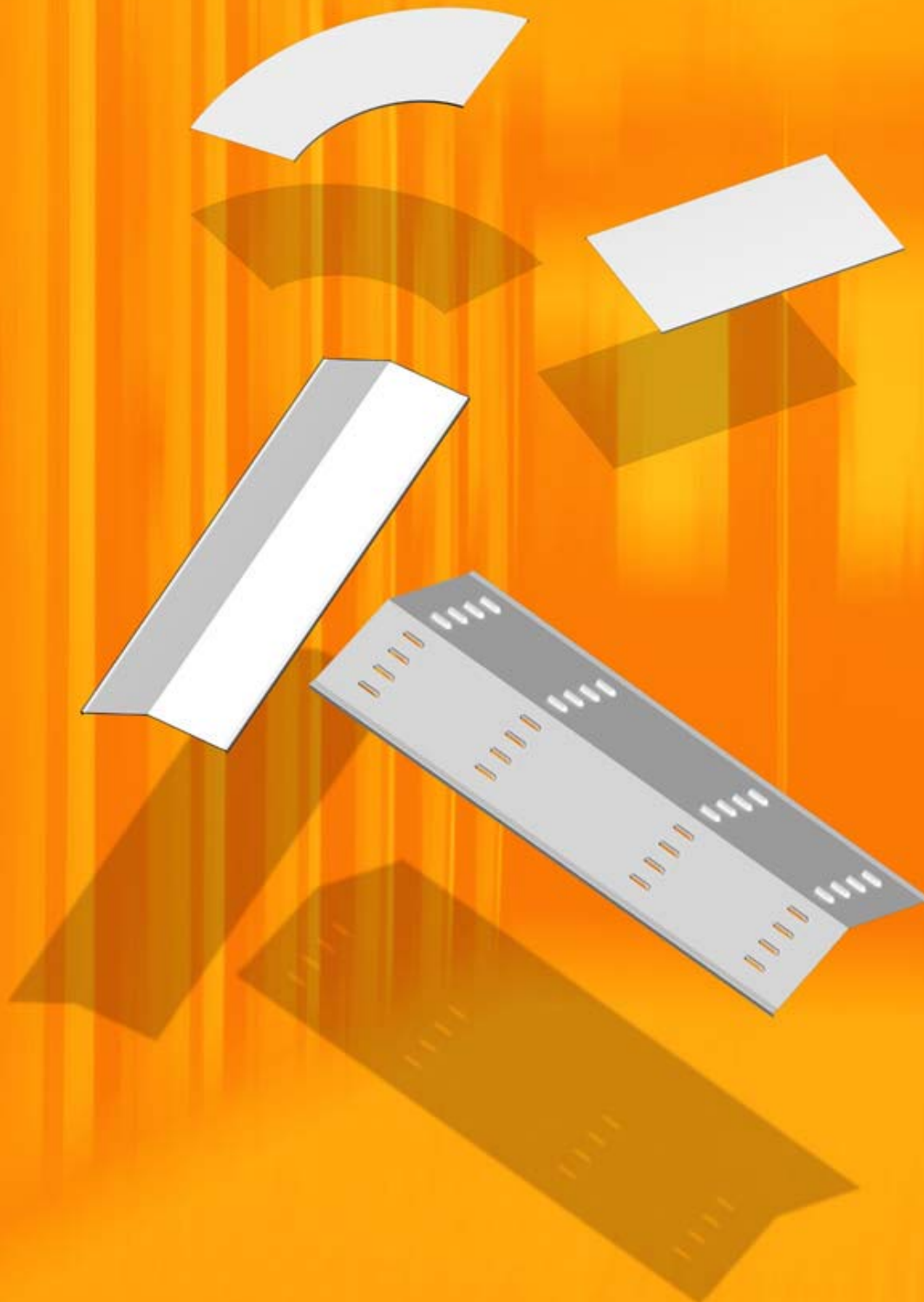

# COVERS

## CABLE/ LADDER TRAY COVERS

### FLAT COVERS

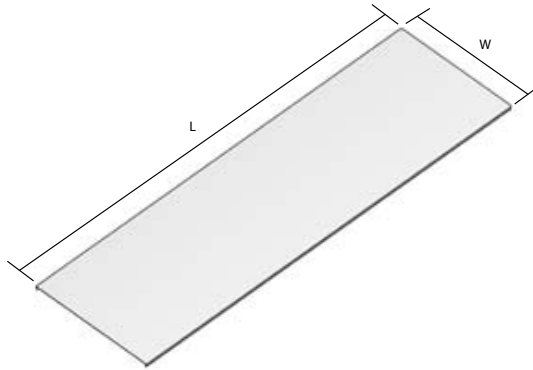

■ IMPRES Flat Covers are manufactured from Sheet metal to suit Eco Trays, LT3, LT5 and Nema Ladders 1, 2, 3 and 4.

**IMPORTANT:** Standard length = 3m. The 2.4m Flat Covers are available on firm orders only

### ECO TRAY FLAT COVERS

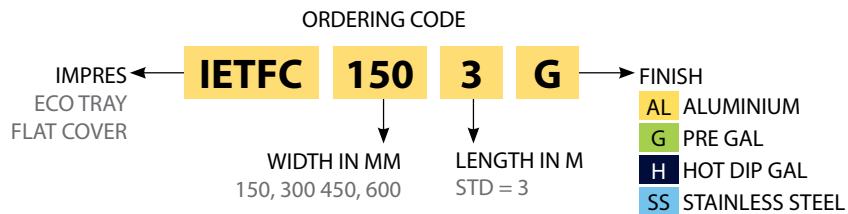

### LT3 / LT5 / NEMA1 FLAT COVERS

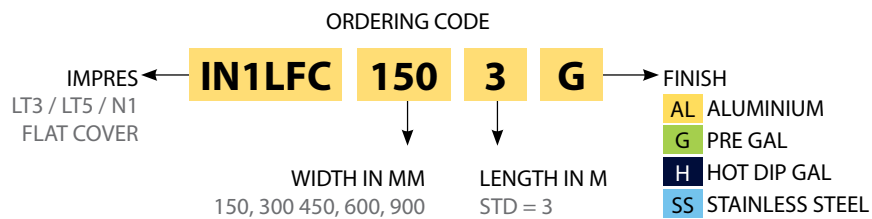

### NEMA 2/3/4 FLAT COVERS

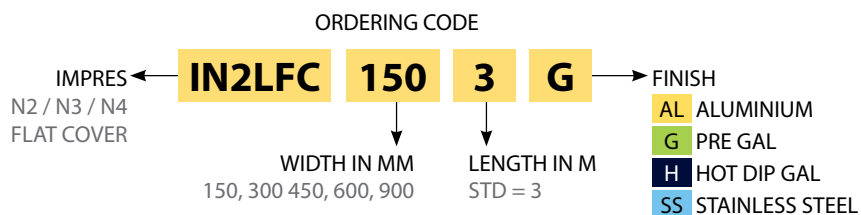

# COVERS

## CABLE/ LADDER TRAY COVERS

### PEAKED COVERS

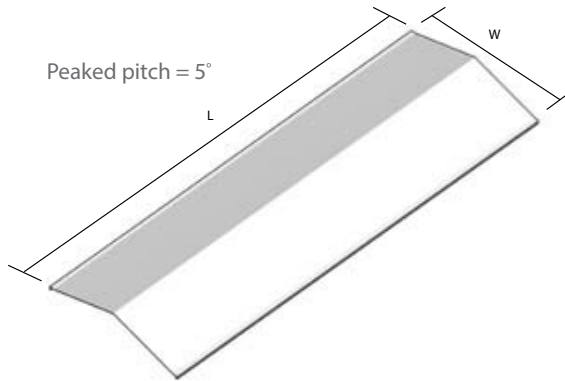

■ IMPRES Peaked Covers are manufactured from Sheet metal to suit Eco Trays, LT3, LT5 and Nema Ladders 1, 2, 3 and 4.

**IMPORTANT:** Standard length = 3m. The 2.4m Peaked Covers are available on firm orders only

### ECO TRAY PEAKED COVERS

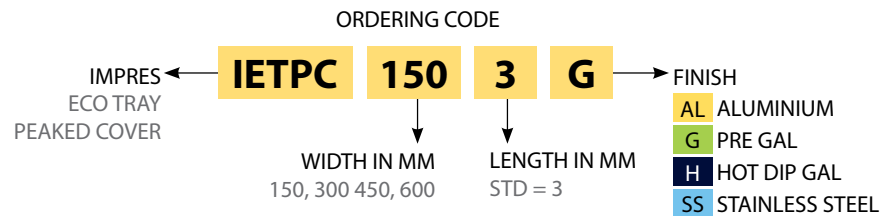

### LT3 / LT5 / NEMA1 PEAKED COVERS

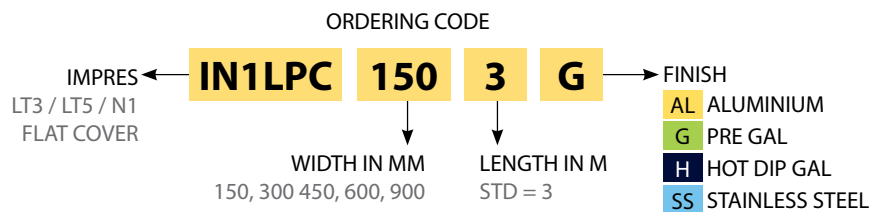

### NEMA 2/3/4 PEAKED COVERS

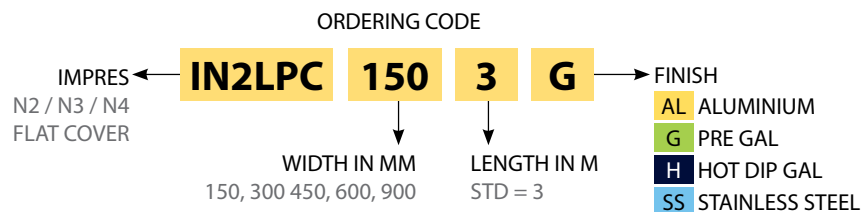

# COVERS

## CABLE/ LADDER TRAY COVERS

### VENTED PEAKED COVERS

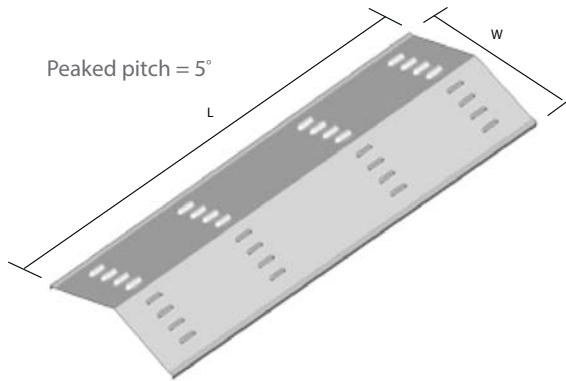

■ IMPRES Vented Peaked Covers are manufactured from Sheet metal to suit Eco Trays, LT3, LT5 and Nema Ladders 1, 2, 3 and 4.

**IMPORTANT:** Standard length = 3m. The 2.4m Vented Peaked Covers are available on firm orders only

### ECO TRAY VENTED PEAKED COVERS

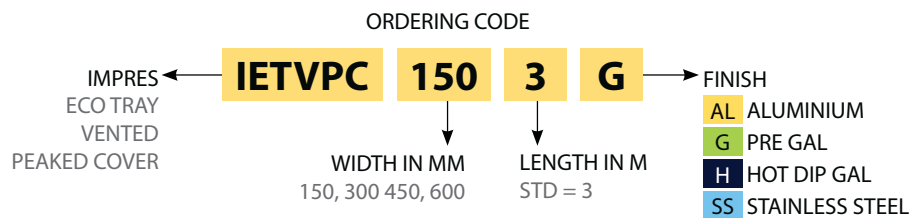

### LT3 / LT5 / NEMA1 VENTED PEAKED COVERS

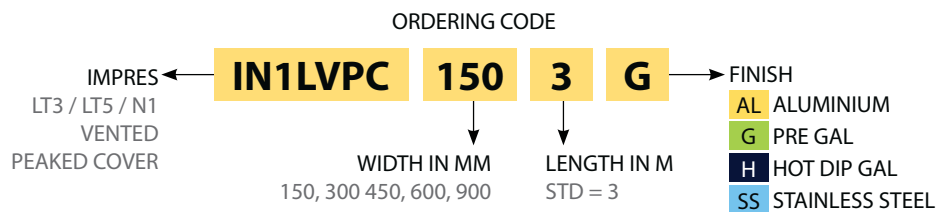

### NEMA 2/3/4 VENTED PEAKED COVERS

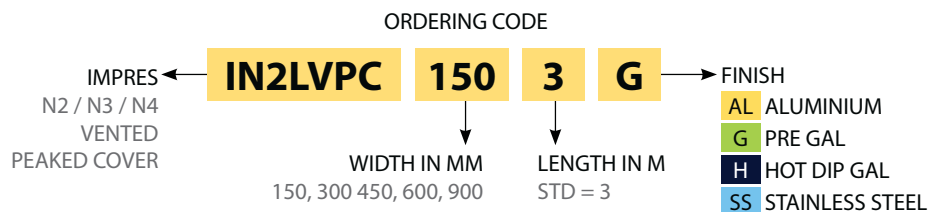

# COVERS

## CABLE/ LADDER TRAY COVERS

### NEMA FLAT BEND COVER

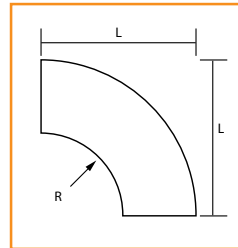
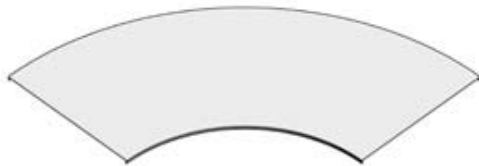

- IMPRES Bend Covers are manufactured from sheet metal to suit Nema Ladders 1,2, 3 and 4.
- Standard Radius for Nema1 Bend is 300 and Nema 2 / 3 is 450.
- Other radius available on firm orders only

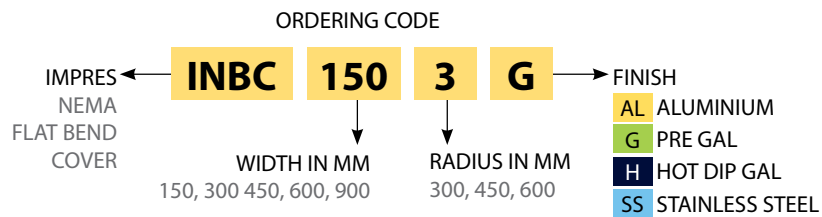

### NEMA FLAT TEE COVER

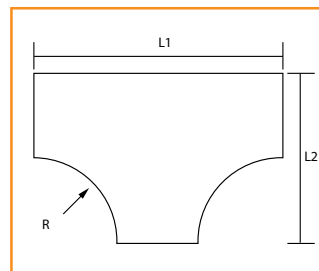
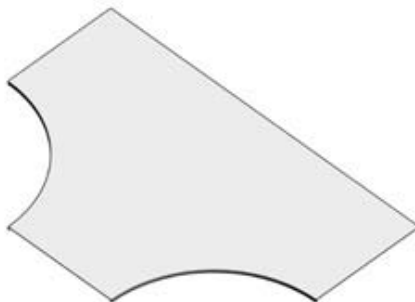

- IMPRES Tee Covers are manufactured from Sheet metal to suit Nema Ladders 1,2, 3 and 4.
- Standard Radius for Nema 1 Tee is 300 and Nema 2/3/4 is 450
- Other radius available on firm orders only

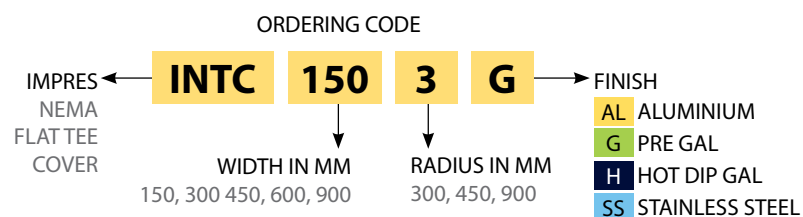

# COVERS

## CABLE/ LADDER TRAY COVERS

### NEMA FLAT EXTERNAL RISER COVER

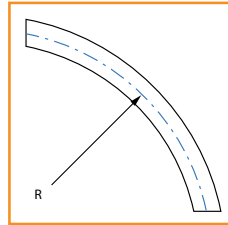

- IMPRES External Riser Covers are manufactured from Sheet metal to suit Nema Ladders 1, 2, 3 and 4.
- Standard Radius for Nema 1 External Riser is 300 and Nema 2/3 is 450.
- Other radius available on firm orders only

ORDERING CODE

IMPRES NEMA FLAT EXTERNAL RISER COVER	<b>INERC</b>	<b>150</b>	<b>3</b>	<b>G</b>	FINISH				
		↓ WIDTH IN MM 150, 300 450, 600, 900	↓ RADIUS IN MM 300, 450, 600						
					<table border="0" style="width: 100%;"> <tr><td style="background-color: #FFD700; padding: 2px;">AL</td> ALUMINIUM</tr> <tr><td style="background-color: #90EE90; padding: 2px;">G</td> PRE GAL</tr> <tr><td style="background-color: #00008B; padding: 2px;">H</td> HOT DIP GAL</tr> <tr><td style="background-color: #4682B4; padding: 2px;">SS</td> STAINLESS STEEL</tr> </table>	AL	G	H	SS
AL									
G									
H									
SS									

### NEMA FLAT INTERNAL RISER COVER

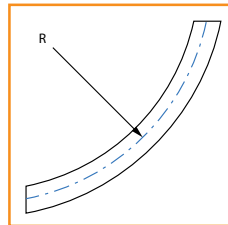

- IMPRES Internal Riser Covers are manufactured from Sheet metal to suit Nema Ladders 1, 2, 3 and 4.
- Standard radius for Nema 1 Bend is 300 and Nema 2 / 3 is 450.
- Other radius available on firm orders only

ORDERING CODE

IMPRES NEMA FLAT INTERNAL RISER COVER	<b>INIRC</b>	<b>150</b>	<b>3</b>	<b>G</b>	FINISH				
		↓ WIDTH IN MM 150, 300 450, 600, 900	↓ RADIUS IN MM 300, 450, 900						
					<table border="0" style="width: 100%;"> <tr><td style="background-color: #FFD700; padding: 2px;">AL</td> ALUMINIUM</tr> <tr><td style="background-color: #90EE90; padding: 2px;">G</td> PRE GAL</tr> <tr><td style="background-color: #00008B; padding: 2px;">H</td> HOT DIP GAL</tr> <tr><td style="background-color: #4682B4; padding: 2px;">SS</td> STAINLESS STEEL</tr> </table>	AL	G	H	SS
AL									
G									
H									
SS									

# COVERS

## CABLE/ LADDER TRAY COVERS

### NEMA STRAIGHT REDUCER FLAT COVER

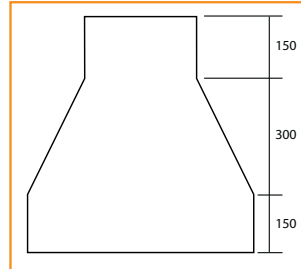
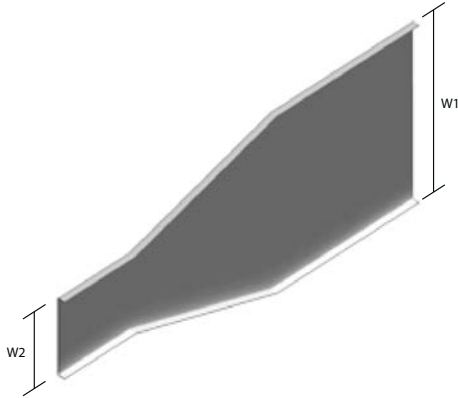

IMPRES Straight Reducer Covers are manufactured from sheet metal to suit Nema Ladders 1, 2, 3 and 4.

#### ORDERING CODE

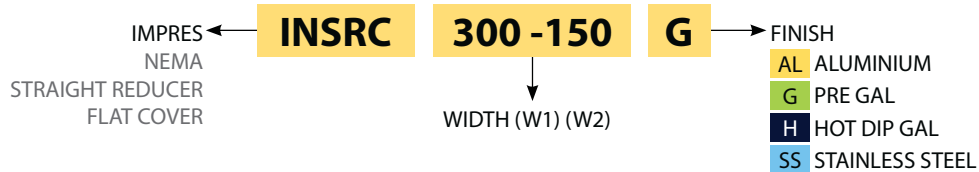

### NEMA LEFT HAND REDUCER FLAT COVER

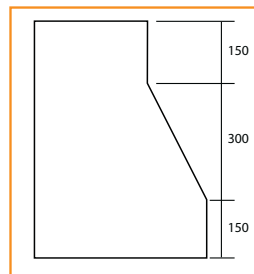
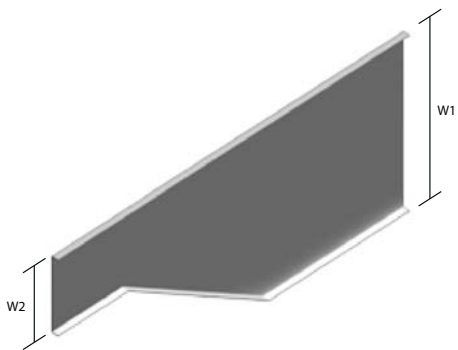

IMPRES Left Hand Reducer Covers are manufactured from Sheet metal to suit Nema Ladders 1, 2, 3 and 4.

#### ORDERING CODE

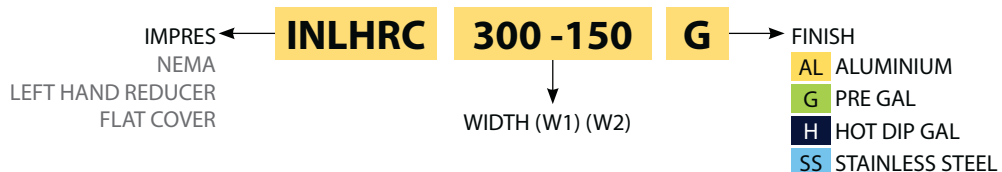

# COVERS

## CABLE/ LADDER TRAY COVERS

### NEMA RIGHT HAND REDUCER FLAT COVER

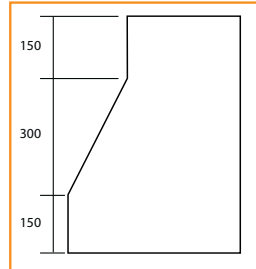
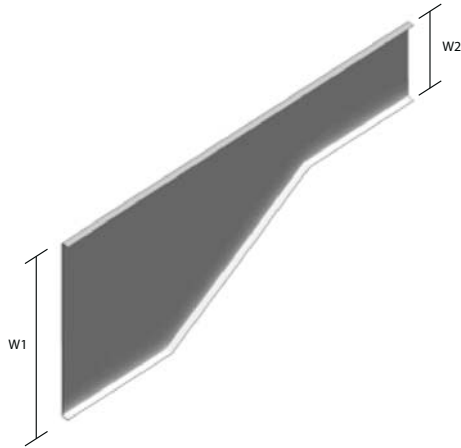

■ IMPRES Right Hand Reducer Covers are manufactured from sheet metal to suit Nema Ladders 1, 2, 3 and 4.

#### ORDERING CODE

IMPRES NEMA RIGHT HAND REDUCER FLAT COVER → **INRHRC** **300-150** **G** → FINISH

AL ALUMINIUM  
 G PRE GAL  
 H HOT DIP GAL  
 SS STAINLESS STEEL

WIDTH (W1) (W2)

### NEMA CROSS FLAT COVER

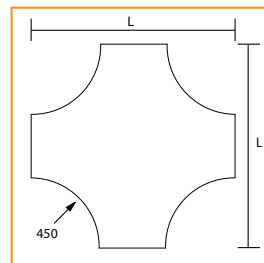

■ IMPRES Cross Covers are manufactured from Sheet metal to suit Nema Ladders 1, 2, 3 and 4.  
 ■ Standard Radius for Nema 1 Cross is 300 and Nema 2/3 is 450.  
 ■ Other radius available on firm orders only

**IMPORTANT:** The Cross Covers are available on firm orders only

#### ORDERING CODE

IMPRES NEMA FLAT CROSS COVER → **INCC** **150** **3** **G** → FINISH

AL ALUMINIUM  
 G PRE GAL  
 H HOT DIP GAL  
 SS STAINLESS STEEL

WIDTH 150, 300 450, 600  
 RADIUS 300, 450, 600



# COVERS

## CABLE/ LADDER TRAY COVERS

### NEMA PEAKED BEND COVER

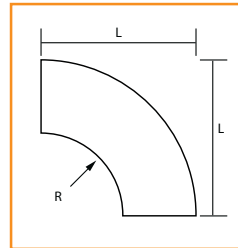

- IMPRES Peaked Bend Covers are manufactured from sheet metal to suit Nema Ladders 1, 2, 3 and 4.
- Standard Radius for Nema1 Bend is 300 and Nema 2 / 3 is 450.
- Other radius available on firm orders only

#### ORDERING CODE

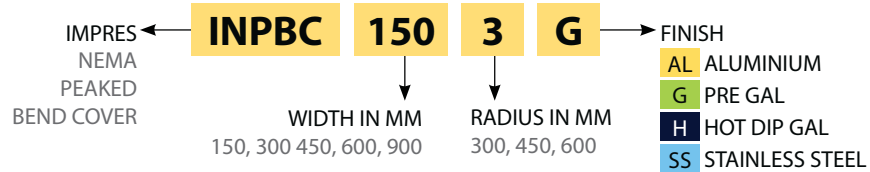

### NEMA PEAKED TEE COVER

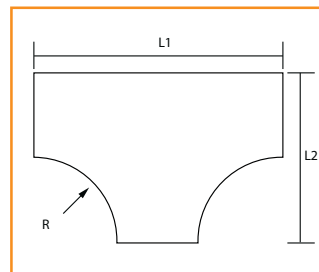
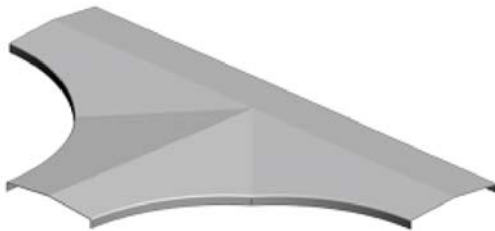

- IMPRES Tee Covers are manufactured from Sheet metal to suit Nema Ladders 1, 2, 3 and 4.
- Standard Radius for Nema 1 Tee is 300 and Nema 2/3 is 450
- Other radius available on firm orders only

#### ORDERING CODE

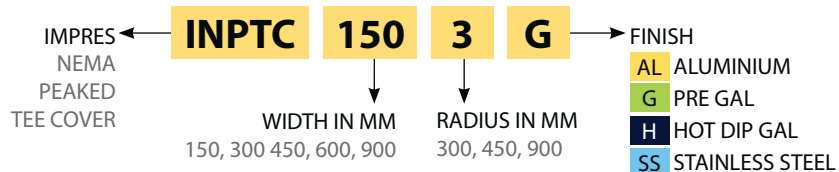

# COVERS

## CABLE/ LADDER TRAY COVERS

### NEMA PEAKED EXTERNAL RISER COVER

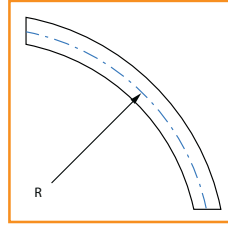

- IMPRES External Riser Covers are manufactured from Sheet metal to suit Nema Ladders 1, 2, 3 and 4.
- Standard Radius for Nema 1 External Riser is 300 and Nema 2/3 is 450.
- Other radius available on firm orders only

ORDERING CODE

IMPRES NEMA PEAKED EXTERNAL RISER COVER	<b>INPERC</b>	<b>150</b>	<b>3</b>	<b>G</b>	FINISH				
		↓ WIDTH IN MM 150, 300 450, 600, 900	↓ RADIUS IN MM 300, 450, 600						
					<table border="0" style="width: 100%;"> <tr><td style="background-color: #FFD700; padding: 2px;">AL</td> ALUMINIUM</tr> <tr><td style="background-color: #90EE90; padding: 2px;">G</td> PRE GAL</tr> <tr><td style="background-color: #000080; padding: 2px;">H</td> HOT DIP GAL</tr> <tr><td style="background-color: #4682B4; padding: 2px;">SS</td> STAINLESS STEEL</tr> </table>	AL	G	H	SS
AL									
G									
H									
SS									

### NEMA PEAKED INTERNAL RISER COVER

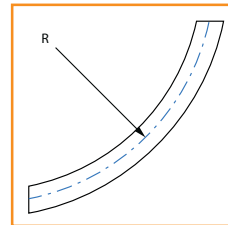

- IMPRES Internal Riser Covers are manufactured from Sheet metal to suit Nema Ladders 1, 2, 3 and 4.
- Standard radius(R) for Nema 1 Bend is 300 and Nema 2 / 3 is 450.
- Other radius available on firm orders only

ORDERING CODE

IMPRES NEMA PEAKED INTERNAL RISER COVER	<b>INPIRC</b>	<b>150</b>	<b>3</b>	<b>G</b>	FINISH				
		↓ WIDTH IN MM 150, 300 450, 600, 900	↓ RADIUS IN MM 300, 450, 600						
					<table border="0" style="width: 100%;"> <tr><td style="background-color: #FFD700; padding: 2px;">AL</td> ALUMINIUM</tr> <tr><td style="background-color: #90EE90; padding: 2px;">G</td> PRE GAL</tr> <tr><td style="background-color: #000080; padding: 2px;">H</td> HOT DIP GAL</tr> <tr><td style="background-color: #4682B4; padding: 2px;">SS</td> STAINLESS STEEL</tr> </table>	AL	G	H	SS
AL									
G									
H									
SS									

# COVERS

## CABLE/ LADDER TRAY COVERS

### NEMA STRAIGHT REDUCER PEAKED COVER

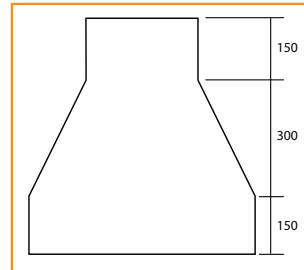
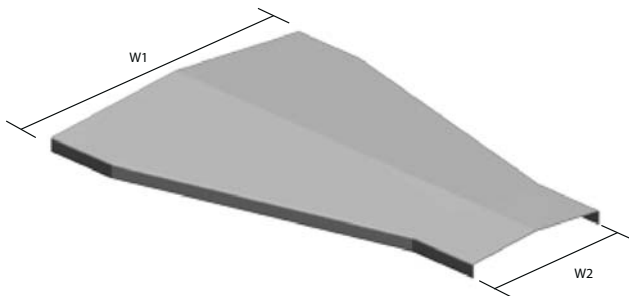

IMPRES Straight Reducer Covers are manufactured from sheet metal to suit Nema Ladders 1, 2, 3 and 4.

#### ORDERING CODE

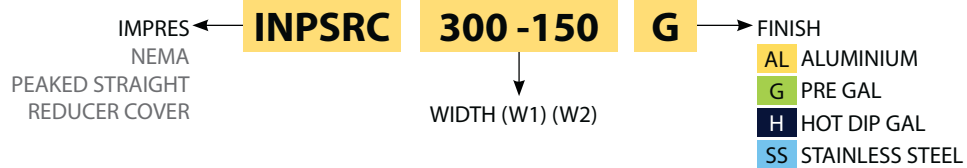

### NEMA LEFT HAND REDUCER PEAKED COVER

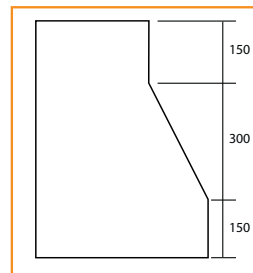
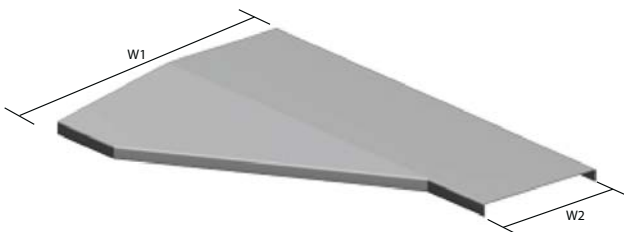

IMPRES Left Hand Reducer Covers are manufactured from Sheet metal to suit Nema Ladders 1, 2, 3 and 4.

#### ORDERING CODE

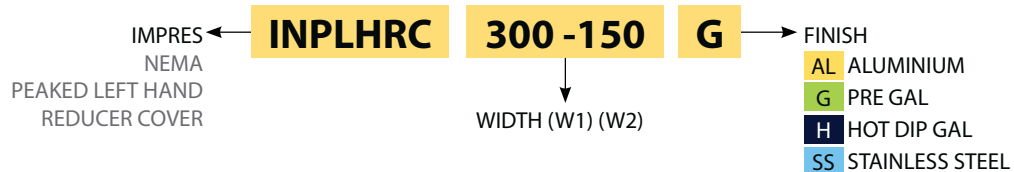

# COVERS

## CABLE/ LADDER TRAY COVERS

### NEMA PEAKED RIGHT HAND REDUCER COVER

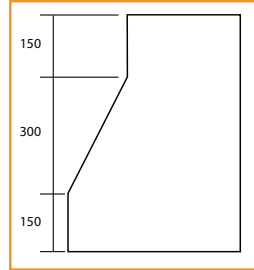
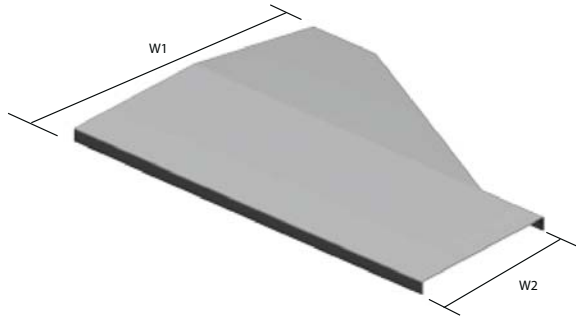

■ IMPRES Right Hand Reducer Covers are manufactured from sheet metal to suit Nema Ladders 1, 2, 3 and 4.

#### ORDERING CODE

IMPRES ← **INPRHRC** → FINISH

NEMA PEAKED RIGHT HAND REDUCER COVER

**300 - 150** → WIDTH (W1) (W2)

**G** → FINISH

- AL** ALUMINIUM
- G** PRE GAL
- H** HOT DIP GAL
- SS** STAINLESS STEEL

### NEMA PEAKED CROSS COVER

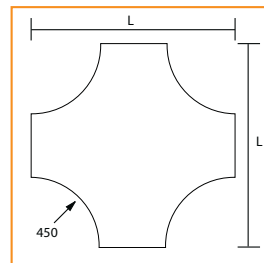

■ IMPRES Cross Covers are manufactured from Sheet metal to suit Nema Ladders 1, 2, 3 and 4.

■ Standard Radius for Nema 1 Cross is 300 and Nema 2/3 is 450.

■ Other radius available on firm orders only

**IMPORTANT:** The Cross Covers are available on firm orders only

#### ORDERING CODE

IMPRES ← **INPCC** → FINISH

NEMA PEAKED CROSS COVER

**150** → WIDTH IN MM  
150, 300 450, 600

**3** → RADIUS IN MM  
300, 450, 600

**G** → FINISH

- AL** ALUMINIUM
- G** PRE GAL
- H** HOT DIP GAL
- SS** STAINLESS STEEL